

 Flexible lightweight silver anodized aluminum construction. Clamp profile makes changing and mounting of banner easy. Height up to 200 cm. Delivered in a grey bag. Padded, black bag is optional. Delivered without banner.

 Einseitiger Banner Stand - einfache und leichte Ausführung. Mit Klemmleisten ist die Montage des Banners schnell und problemlos. Höhe bis zu 200 cm. In grauem Beutel geliefert. Kräftige schwarze Tasche als Zubehör. Wird ohne Banner geliefert.

 Enkelt-sided bannerstand - fleksibel letvægtskonstruktion i sølv-eloxeret aluminium. Klemprofil i top og bund gør det let at montere og udskifte banneret. Højde op til 200 cm. Leveres i grå pose. Kraftig, sort taske kan købes som tilbehør. Leveres uden banner.



**We recommend**  
200-310 g  
polyester  
banner material

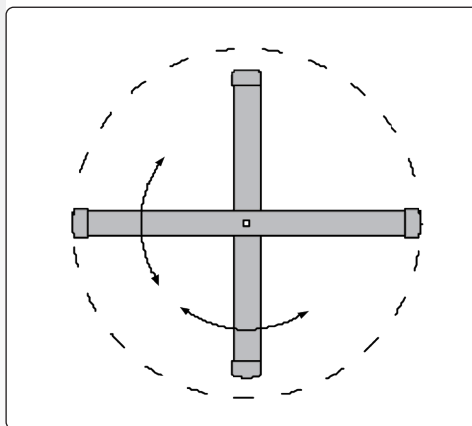
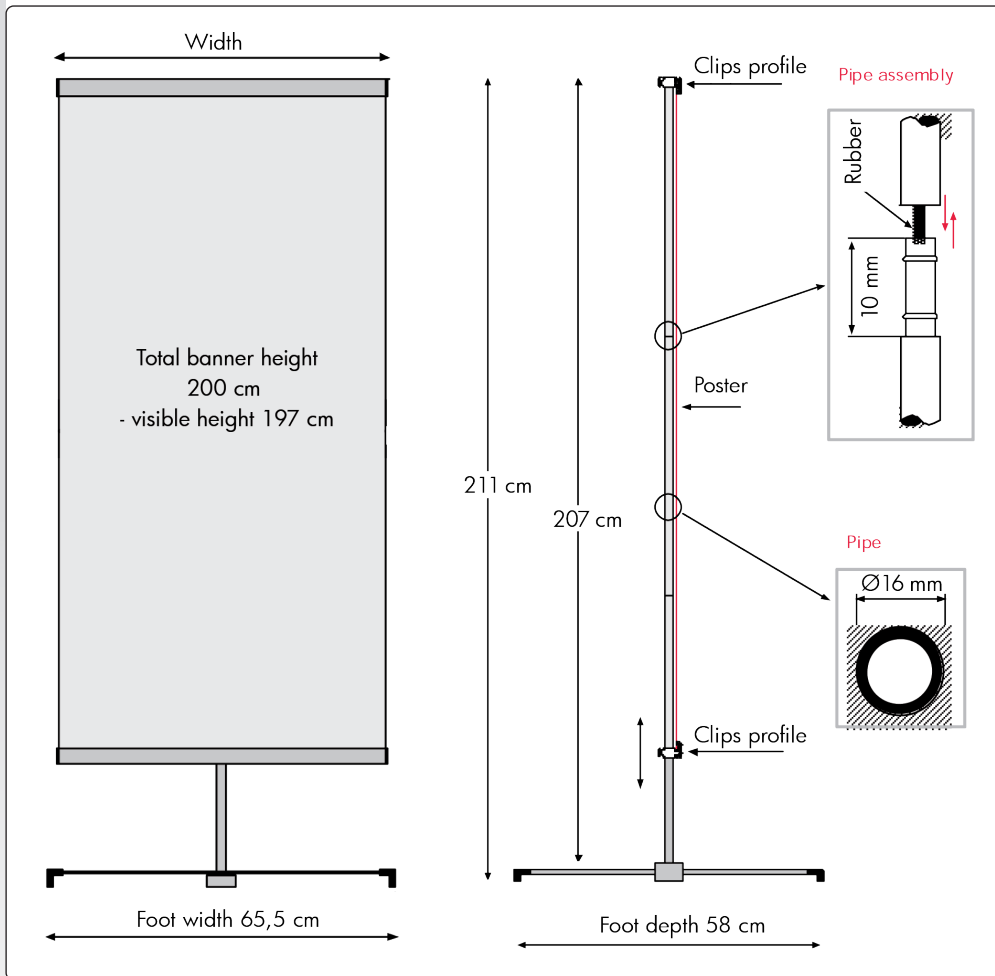
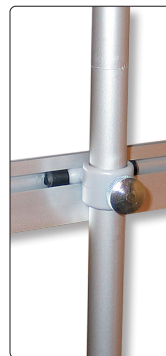
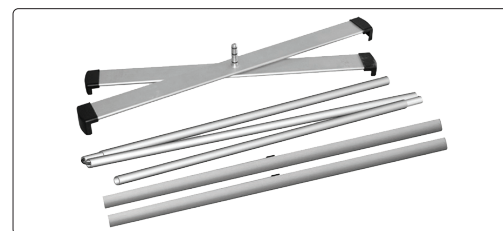

Model	Article	Product	Visible Banner	Color	Total W x H	Package size and weight	Pallet size and quantity
416	4697	Stand 60 x 200 cm	60 x 197 cm	Alu	65,5 x 211 cm	10 x 75 x 10 cm 2,4 kg	80 x 120 x 220 cm 250 pcs.
	46970	Bag		Black		16 x 85 x 16 cm 0,5 kg	80 x 120 x 220 cm
416	4698	Stand 80 x 200 cm	80 x 197 cm	Alu	85,5 x 211 cm	10 x 83 x 10 cm 4,0 kg	80 x 120 x 220 cm 250 pcs.
	46980	Bag		Black		16 x 85 x 16 cm 0,5 kg	80 x 120 x 220 cm
	4519	Spotlight 50 W		Alu		8 x 7 x 46 cm 0,5 kg	80 x 120 x 220 cm 400 pcs.

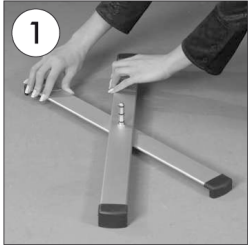

- Open the legs in plus (+) position.
- Öffnen Sie die Füße in Kreuzstellung.

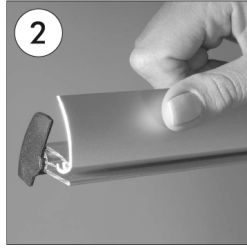

- Open the top clamp profile and place in the poster. Place in the other end of poster to bottom clamp.
- Machen Sie obere Klemmleiste auf, legen das Poster hinein und klemmen sie zu. Machen Sie untere Klemmleiste auf, legen das andere Ende des Posters hinein und klemmen sie zu.

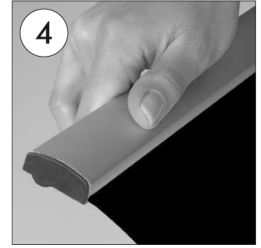
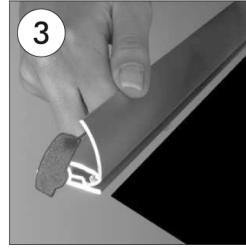

- Complete the assembly of 3 part pipe.
- Stecken Sie das 3-teilige Rohr ineinander zu einem Stück.

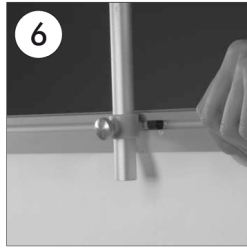

- Hang the banner by sliding the plastic connectors over the pipe.
- Führen Sie das Poster durch die auf der Rückseite der Klemmleisten befindlichen Plastikhalterungen durch das Rohr.

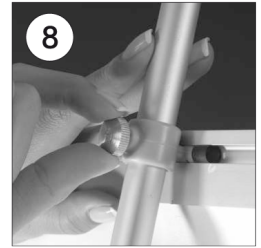
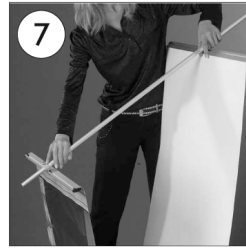

- Screw the top and bottom plastic connectors to fix the banner clamps.
- Ziehen Sie diese Plastikhalterungen an den Schrauben fest.

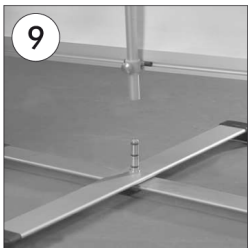

- Fit in the pipe on the bar of the base.
- Stecken Sie das Rohr auf den Steckbolzen auf dem Fuss auf und hängen somit das Poster auf.

